

## CONTENTS

1) Foreword .....	page 2
2) Dimensions .....	2
3) General description .....	3
4) Packaging .....	3
5) Disposal .....	4
6) Use .....	4
7) Installation and wiring .....	5
8) Operation of the appliance .....	6
9) Warnings regarding operation .....	9
10) Safety devices .....	9
11) Warnings regarding safety .....	10
12) Noise levels .....	11
13) Maintenance .....	11
14) Cleaning the appliance .....	12

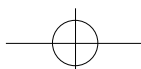

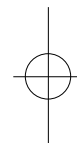
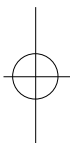
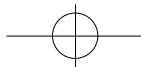

## 1) FOREWORD

Read this manual from cover to cover before using the appliance as it contains important instructions for the safety, operation and maintenance of the appliance. Look after this manual and keep it in a safe place.

The manufacturer reserves the right to make changes to the product and to the manual.

## 2) DIMENSIONS

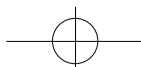
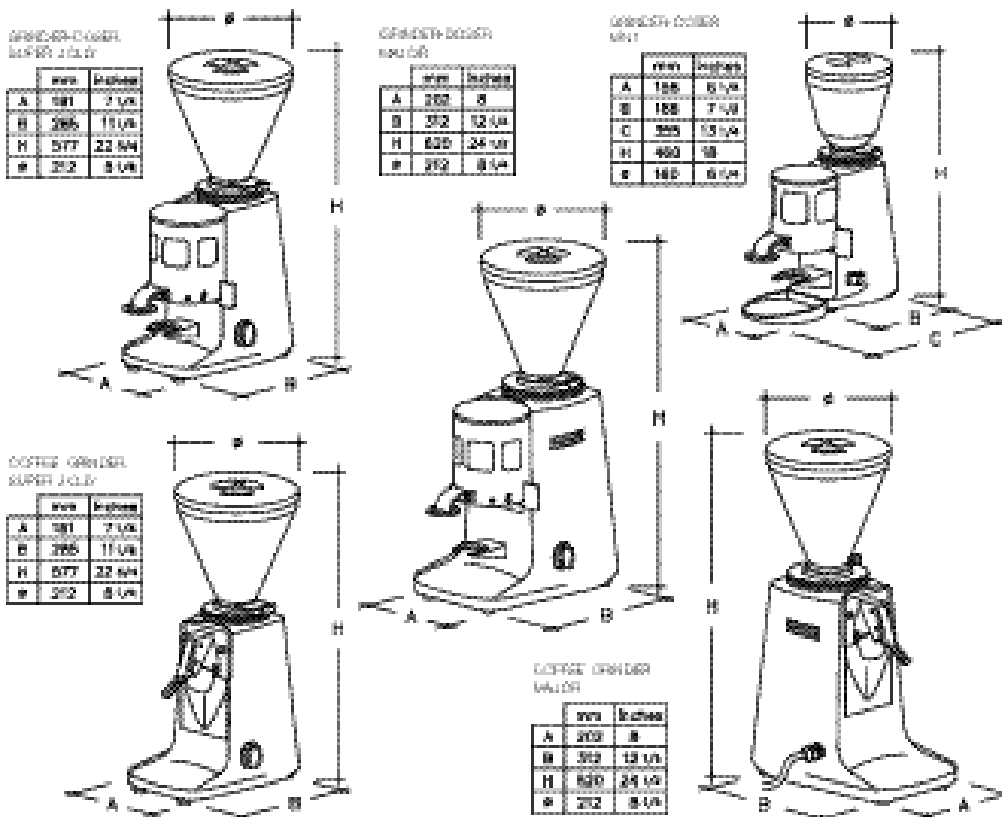

### 3) GENERAL DESCRIPTION

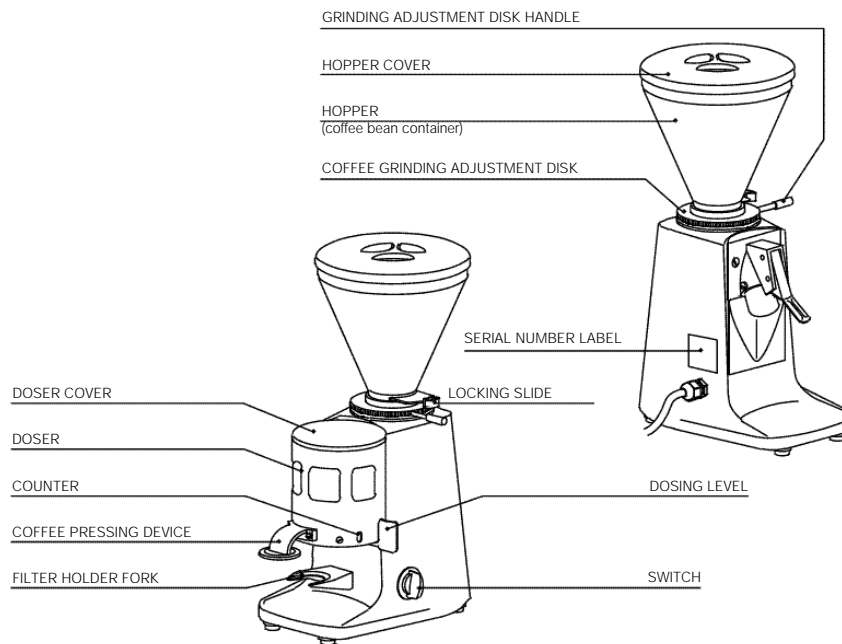

### 4) PACKAGING

On opening the packaging, check carefully to make sure the appliance is intact and that there are no signs of damage. If in any doubt, do not use the unit and contact personnel with the appropriate professional skills.

The packaging materials must be kept out of the reach of children as they represent a potential source of danger.

Keep the packaging until the warranty has expired.

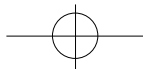

## 5) DISPOSAL

---

Do not litter: dispose of the packaging materials according to the laws in force. Should you decide not to use the appliance any more, remember to unplug it so that it cannot be used, and cut the cable in the point where it comes out of the appliance.

Contact specialized firms for information on the disposal of the components of the appliance.

## 6) USE

---

This appliance has been designed solely for grinding coffee beans. Any other use is understood to be improper, and consequently hazardous. The manufacturer cannot be held responsible for any damage as a result of improper or incorrect use.

Do not use the appliance for grinding other types of food, or anything else.

Do not use the doser (grinder-doser version) to store foods or measure them.

The coffee grinders and coffee grinder-dosers manufactured by our company are intended for professional use only. The user must be an adult.

Do not allow children or incapable persons to use the appliance.

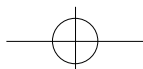
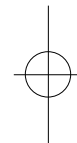
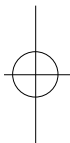

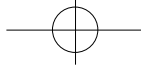

## 7) INSTALLATION AND WIRING

The appliance must be installed by skilled technical personnel in conformity with the safety rules in force. Incorrect installation may result in injury of persons or animals, or damage to property, for which the manufacturer cannot be held responsible.

- The appliance must be placed on a stable, flat surface.
- Before plugging in the appliance, make sure the voltage and frequency values of the supply mains correspond to the ratings indicated on the label featuring the appliance's technical data.
- The wall socket must be fitted with an efficient earth contact. Consequently, it is essential to make sure the earth system is efficient and in conformity with current safety rules. If in any doubt, have the system thoroughly checked by personnel with the appropriate professional skills.

**IT IS COMPULSORY TO EARTH THE APPLIANCE.**

The manufacturer cannot be held responsible in the event this regulation is not complied with.

- It is essential to make sure the ratings of the system are suitable for the power absorbed by the appliance - as indicated on the label featuring the technical data - and that the wall socket is protected against overcurrents.
- Do not use extension cables, plug adapters for multiple sockets or makeshift connections.
- In EEC member countries, the regulation in force calls for the external equipotential terminal on the outer part of the appliance's base plate to be connected to a equipotential node if the installation is to be correct. 
- The motor must rotate clockwise. If the rotation of three-phase motors is to be inverted, by inverting the two power supply wires inside the plug, this must be carried out by skilled personnel.
- **THE HOPPER MUST BE FASTENED TO THE APPLIANCE'S GRINDING SYSTEM BY MEANS OF THE RELEVANT SCREW** which must be inserted in the threaded hole located on the upper grinding blade holder and in the hole on the neck of the hopper.

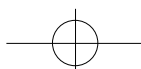

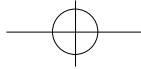

## 8) OPERATION OF THE APPLIANCE

### PRELIMINARIES

Make sure the hopper is positioned correctly on the appliance and is fastened to the upper grinding blade holder by means of the relevant screw.

Close the locking slide and fill the hopper with coffee beans. Open the locking slide so that the beans are allowed to drop into the grinding system.

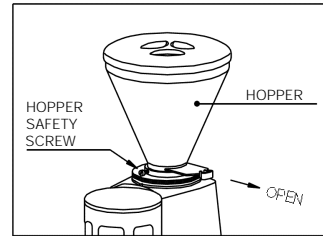

### SWITCHING THE APPLIANCE ON AND OFF

#### GRINDER-DOSERS WITH MANUAL SWITCH AND COFFEE GRINDERS

The on-off switch is used to turn the appliance both on and off.

To switch on: set the switch to I.

To switch off: set the switch to O.

#### GRINDER-DOSERS WITH TIME SWITCH

In order to switch the appliance on, turn the timer knob clockwise.

The appliance switches off automatically. In order to switch it off manually, turn the knob anticlockwise all the way.

#### AUTOMATIC GRINDER-DOSERS

In order to power up the appliance, turn the on-off switch knob to I. In order to switch the appliance on manually, the switch knob must be turned all the way (to START).

The appliance starts up automatically every 12 portions of coffee (every 6 portions in the MINI model). It switches off automatically when the doser is filled with ground coffee.

In order to switch off the appliance manually, set the on-off switch knob to O.

### ADJUSTING GRINDING

In order to achieve finer or coarser grinding, the adjustment disk located under the hopper must be adjusted using the relevant handle.

In order to increase the coarseness of the ground coffee, the disk must be rotated clockwise; to decrease, turn the disk anticlockwise.

The disk remains in the chosen position without having to be locked in place.

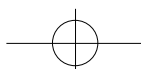
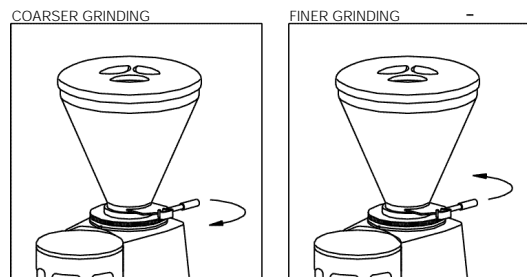

The adjustment must be performed with the motor on, and preferably without any coffee between the grinding blades.

Grind small amounts of coffee in order to determine the optimal degree of fineness. In the grinder-doser version, if the coffee comes out of the espresso coffee machine very quickly, it means the coffee is ground too coarse. Vice versa, if it comes out too slowly, it means the coffee is ground too fine. Nonetheless, bear in mind that there are many conditions liable to influence the correct supply, such as the weight of the portions, the compacting, the espresso machine settings, and the cleaning of the filters.

### **COFFEE DOSE ADJUSTMENT (grinder-doser version)**

In order to adjust the size of the portion dispensed, the small knob located in the centre of the ground coffee storage container must be turned while holding still the star shaped dosing unit.

By turning the small knob clockwise, the portion is reduced. Turning it anticlockwise results in an increase.

In order to collect the portions of ground coffee dispensed, insert the coffee machine's filter holder all the way onto the fork-shaped support under the ground coffee outlet.

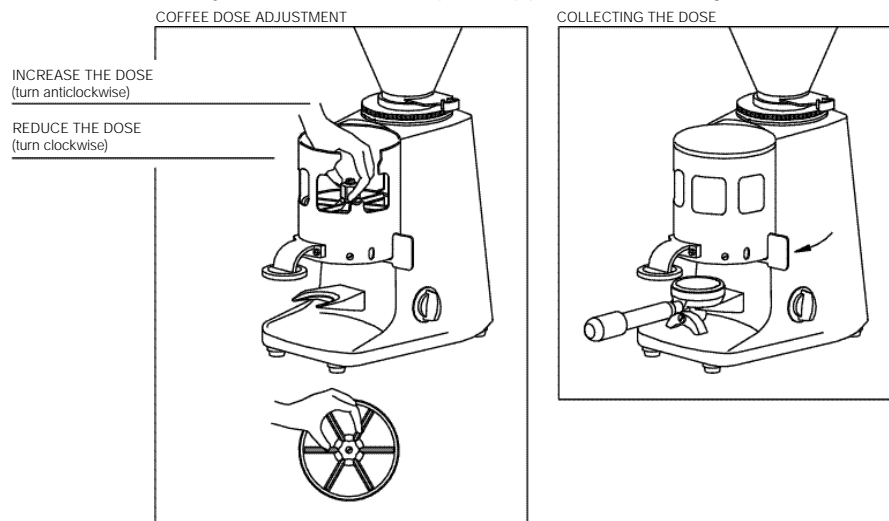

In order to release a portion of ground coffee, the doser lever must be pulled all the way and allowed to return on its own. Pull twice in a row for a double portion.

In manual coffee grinder-dosers and those with time switches, in order to assure the portions are regular, check every now and again to make sure the amount of coffee ground to be found in the doser is sufficient to cover the feeding star unit.

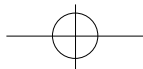

**PRESSING (grinder doser version)**

**STATIC PRESSING DEVICE**

Place the filter holder against the underside of the pressing device and push upwards

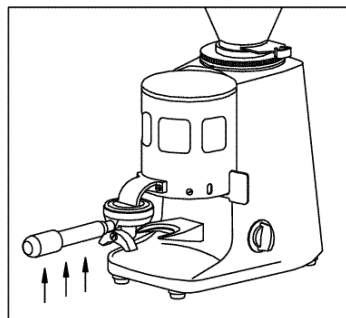

**SPRING PRESSING DEVICE**

Place the compacting disk against the upper face of the filter holder inserted in the fork-shaped support and press down on the spring pressing device knob

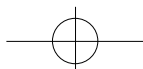
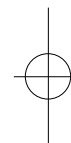
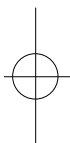
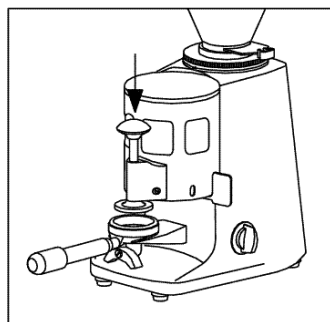



## 9) WARNINGS REGARDING OPERATION

- Never leave the automatic coffee grinder-dosers on without coffee in the hopper.
- In the grinder-doser version, avoid pulling the doserlever partially, always pull it all the way.
- In the coffee grinder version it is essential that nothing hinders the flow of ground coffee from the outlet in any way in order to prevent the risk of the appliance stopping. Consequently, avoid using coffee bags which are too small with respect to the amount of coffee to be ground.
- OPERATING RANGE OF THE MOTOR:  
IN THE VERSIONS WITH SINGLE-PHASE MOTORS, THE APPLIANCE CAN BE ALLOWED TO WORK FOR A MAXIMUM OF 30 MINUTES, AFTER WHICH IT MUST BE TURNED OFF AND ALLOWED TO COOL DOWN.  
In order to achieve good grinding, it is nonetheless recommended to operate the appliance at intervals, allowing it to operate for no more than 10-15 minutes at a time.

## 10) SAFETY DEVICES

- THERMAL OVERLOAD PROTECTION  
The appliance's motor is protected against overheating resulting from overcurrents by a thermal overload protection which, when tripped, cuts off the power supply to the motor. Should the protection trip as a result of anomalous operation, such as the grinding blades jamming, the appliance must be turned off using the on-off switch, unplugged from the mains, and skilled technical personnel contacted.  
Never perform any work on the appliance while it is attached to the mains.  
If the appliance overheats as a result of the motor stopping, allow the appliance to cool down before performing any repair work.
- The hopper must always be attached to the upper grinding blade holder using the relevant screw, which must not be removed by the user under any circumstances.
- In order to prevent the adjustment disk from being removed - which would make the rotating parts accessible - there is a safety screw on the actual disk: said screw must be positioned in whichever of the two holes on the disk enables the wider and most suitable range of grinding adjustment, and must not be removed by the user under any circumstances.

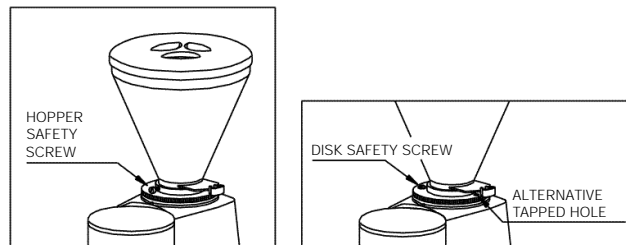

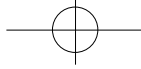

## 11) WARNINGS REGARDING SAFETY

---

This electrical appliance must be used in conformity with the rules in force governing safe operation.

- WHEN OPERATING THE APPLIANCE, BEWARE OF THE MOVING MECHANICAL PARTS' IN THE AREA OF THE GRINDING BLADES AND OF THE GROUND COFFEE OUTLET.  
BEFORE REMOVING THE HOPPER FROM THE GRINDING SYSTEM, DISCONNECT THE POWER SUPPLY.  
AVOID REMOVING FOREIGN BODIES FROM THE GRINDING SYSTEM OR HOPPER WITHOUT FIRST UNPLUGGING THE APPLIANCE FROM THE MAINS.
- Take care, as the grinding blades may continue rotating for a short while even after the appliance is switched off.
- In the event the appliance is not working properly or is faulty, contact skilled technical personnel, and do not attempt to make repairs yourself.
- Do not tamper with the appliance.
- BEFORE PERFORMING ANY WORK ON THE APPLIANCE, INCLUDING CLEANING AND/OR MAINTENANCE, DISCONNECT IT FROM THE POWER SUPPLY BY UNPLUGGING.  
TURNING OFF THE APPLIANCE USING ITS MASTER SWITCH DOES NOT ASSURE THE SAME CONDITIONS OF SAFETY.
- Do not touch the appliance with damp or wet hands or feet.
- Do not use the appliance barefoot.
- Do not tug on the supply cable to unplug the appliance from the mains.
- Do not let liquids of any kind come into contact with the internal or external parts of the appliance.
- Never put ground coffee in the hopper intended only for coffee beans.
- When the appliance is left unattended, the appliance's power supply must be disconnected using its master switch (for example, at night, during work breaks, midweek closing or holidays).
- THE USER IS NOT AUTHORIZED TO REMOVE SCREWS OR ANY PARTS SCREWED ONTO THE APPLIANCE.

The manufacturer cannot be held responsible for bodily injury or damage to property if these regulations are not complied with.

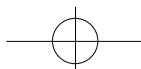

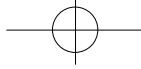

## 12) NOISE LEVEL

---

The noise level, determined in the workplace (at a distance of 1 metre), of the coffee grinders and grinder-dosers manufactured by our company is less than 74 dB. Said level has been determined on identical new appliances.

## 13) MAINTENANCE

---

In order to assure the lasting efficiency of the appliance, skilled technical personnel must be called in to perform periodical maintenance, including detailed checks of the state of those components subject to wear.

The state of the grinding blades must be checked periodically. Keeping the grinding blades in an excellent state assures high-quality grinding, resulting in greater productivity and limited overheating.

When using coffee blends of average hardness, it is advisable to replace the grinding blades approximately every:

600 kg for the Major model

400 kg for the Super Jolly model

300 kg for the Mini model.

It is essential to check the state of the supply cable and plug periodically.

IN THE EVENT THE SUPPLY CABLE OR PLUG ARE DAMAGED, CALL IN SKILLED TECHNICAL PERSONNEL TO REPLACE THEM.

IN CE-CERTIFIED APPLIANCES, A SPECIAL TOOL IS REQUIRED TO OPEN THE BASE PLATE TO GET AT THE CABLE.

It is recommended to use original spare parts only.

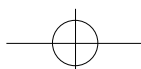

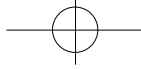

## 14) CLEANING THE APPLIANCE

---

DISCONNECT THE APPLIANCE'S POWER SUPPLY BY UNPLUGGING IT BEFORE CLEANING.

THE APPLIANCE MUST NOT BE CLEANED USING WATER JETS.

Do not install the appliance in rooms where water jets are used for cleaning.

THE APPLIANCE MUST BE CLEANED PERIODICALLY BY SKILLED TECHNICAL PERSONNEL ONLY.

Use perfectly clean, disinfected cloths or brushes for cleaning.

Do not use abrasive products as these are liable to take the sheen off shiny parts.

### **Hopper**

Wash the hopper once it has been removed from the appliance (unscrewing the relevant fastening screw), using neutral soap and water, rinse abundantly with lukewarm water and dry thoroughly.

It is advisable to clean the hopper periodically.

Once the hopper has been cleaned, it must be attached to the upper grinding blade holder using the relevant screw.

### **Grinding system**

Remove the safety screw which prevents the adjustment disk from being removed. Unscrew the adjustment disk by turning it clockwise. Having removed the upper grinding blade holder, clean the grinding blades, threads and the entire grinding system thoroughly using a clean brush and cloth.

Having refitted the upper grinding blade holder in the relevant slot, screw the adjustment disk back on, put the self-locking screw back in whichever of the two holes on the disk enables the best adjustment and, having refitted the hopper and secured, adjust the grinding as required.

### **Doser (Coffee grinder-version)**

Having discharged the ground coffee, clean the doser's star unit with a clean brush, expelling the material removed by pulling the doser lever.

Use a dry cloth to thoroughly clean the outlet of the ground coffee on the bottom of the doser.

### **Spout (Coffee grinder with bag holder)**

Wipe clean the spout from which ground coffee is released using a dry cloth.

*Last revised: SJ00 11/2000*

