

LELIT

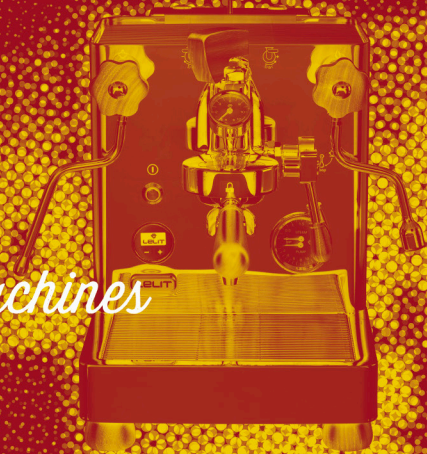

Espresso Machines

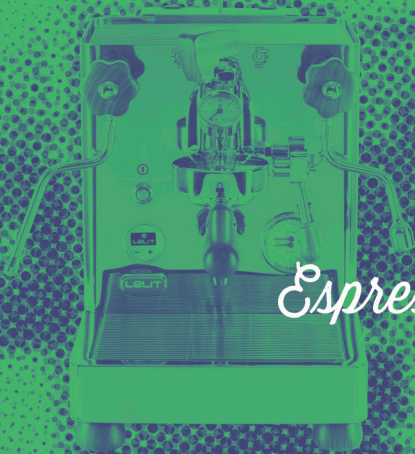

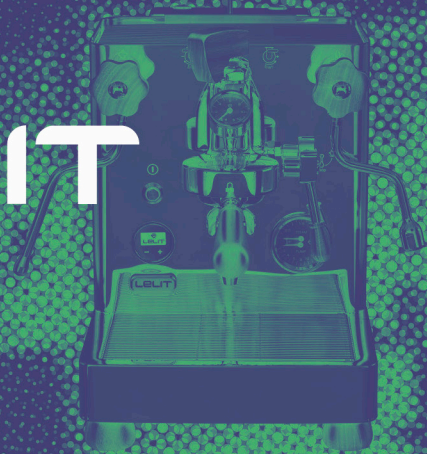

It's coffee time

Lelit espresso machines are designed and produced in Italy, implementing the same technologies and components used for the commercial bar machines.

Every single espresso machine has been conceived and designed to grant the optimal temperature and water pressure conditions needed for exceptional espressos.

Thanks to these espresso machines you can take home a piece of Italian history.





Coffee is the balm of the heart
and of the spirit.

Giuseppe Verdi



an Espresso

LIKE AT THE BAR

Italian bars have spread the culture of the Espresso around the world and are the best place where you can enjoy it.

With our machines you'll be able to enjoy the flavor of an Italian breakfast every time you want, brewing for you, your family and your friends an espresso, a cappuccino, an American coffee or a Latte macchiato just like a real barista.

with our machines
you can brew



ESPRESSO



AMERICAN
COFFEE



CAPPUCCINO



LATTE
MACCHIATO



an Espresso
AS AN ALCHEMY

To prepare a great Espresso you need a bit of magic and creativity... There must be a perfect balance between water temperature, powder tamping, grinding degree and blend quality.

Thanks to all the devices of Lelit espresso machines it's all in your hands: you can set all the parameters and refine the art of brewing great espressos, just like a real barista.

with our machines
you can set



THE GRINDING



THE BLEND
QUANTITY



THE WATER
TEMPERATURE



THE WATER
PRESSURE

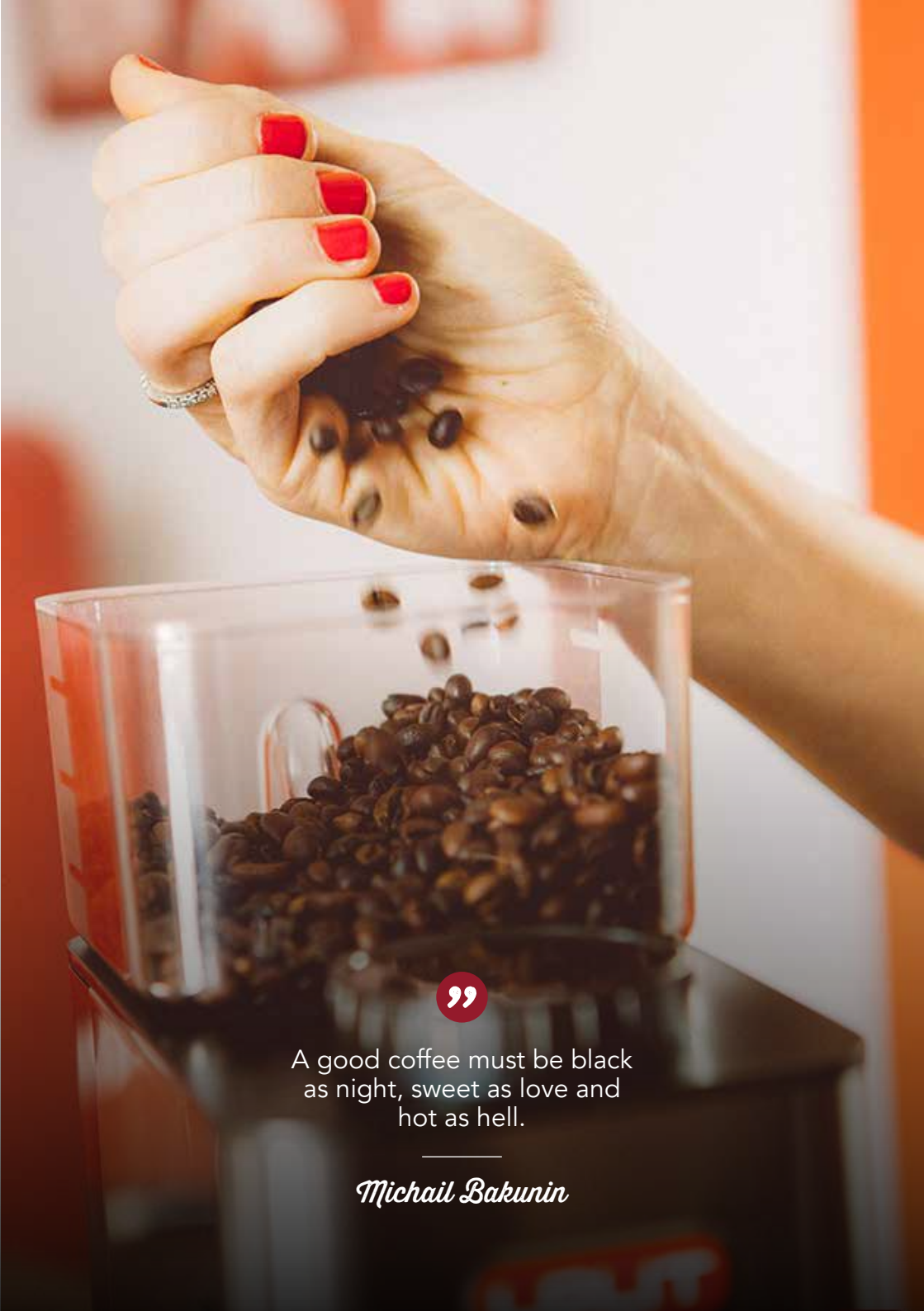

”

A good coffee must be black
as night, sweet as love and
hot as hell.

Michail Bakunin



”

Man was born to create. Human vocation is to imagine, invent and dare new challenges.

Michael Novak



an Espresso

MADE IN ITALY

Lelit espresso machines are designed and made in Italy using the components and the technologies adopted for the professional bar machines. By purchasing a Lelit machine you'll take home a machine conceived, designed and produced for real Espresso lovers.

Our research and development department cooperates with external designers to create beautiful, ergonomic machines that grant a more and more enchanting and gratifying experience.

our machines are
projected with



QUALITY
COMPONENTS



FUNCTIONAL
DESIGN



DETAILS
CARE



HIGH
TECHNOLOGY



TECHNOLOGY AND DESIGN

according to Lelit

DESIGN MUST INTERPRET
THE USER NEEDS AND GIVE
PRECISE RESPONSE IN TERMS OF
FUNCTIONALITY, AESTHETICS AND
ATTENTION TO DETAIL.

The materials, the finishing and the machine user interface have been chosen and developed with utmost care and extreme attention: the interface is the union of light and graphic signals and shows consistency between the user actions and the machine reactions.

Lelit moved away from a round filterholder handle to a square shaped handle to make it more comfortable and have a functional support during coffee tamping. The lines of the appliance body have become soft and harmonic.



1 LCC

Lelit Control Center is the new brain of Lelit espresso machines. It appears with a new LCD graphic display of the latest generation and enhances a system for controlling all the machine functions and giving precious advice to get excellent results.

LWC

Lelit Water Control is an innovative probe that combines the function of a temperature probe and of a water level probe inside the boiler. A unique device that gives a better control of the vital parameters of the machines heart, i.e. the boiler.

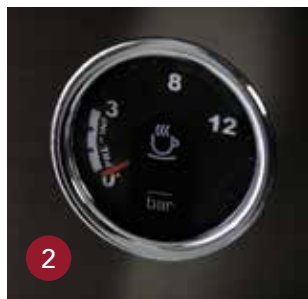

2 PRE-INFUSION

Lelit has studied and developed a new pre-infusion system working on the steam boiler, optimizing this important and delicate phase to get the best from the coffee extraction. A unique and innovative procedure that was exclusive of the professional bar machines and that is now available also in the domestic machines.

3 COFFEE SLIDE

Coffee slide is the new Lelit patented spout to better accompany/guide the coffee into the cup and actively contribute in the espresso creation. Progressive inclination, slide length and open surfaces are masterfully calibrated to get the best possible result.



4 DESIGN

Lelit believes that design is a distinctive and defining feature of its products. For this reason, we started cooperating with young Italian designers that work together with our technical department to build machines that are more and more functional, performing and elegant.

5 PADDLE

The paddle is Lelit last invention implemented in the semi-professional machines for domestic use. Rotating, it gradually opens or reduces the water flow inside the group, enabling the highest, manual pressure profile personalization of every single phase of the coffee extraction. This gives the possibility to get the best out of every coffee blend, managing the main palate sensations of body, acidity, bitterness and astringency according to the different tastes and to the barista's personality.



A designer knows that he has reached perfection when there's nothing left to be removed.

Antoine de Saint-Exupéry



HAVE A LOOK AT THE VIDEO
to discover how to get the best
from our espresso machines



50s

— Line —

It's a line inspired to the 50s, when many icons of modern design were born: Vespa, Fiat 500, Lettera 22 – the Olivetti typewriter.

The clean silhouettes, the extensive use of stainless steel, the minimalist design driven by functionality in every detail make Lelit espresso machines outstanding pieces of Italian excellence.



Families:

ANNA · ANITA · GLENDA · DIANA



ground
coffee



coffee
pods



Dimensions: 23x26,5x34 cm

Weight: 7,2 kg

Pump: 15 bar

Tank capacity: 2,7 l

Total power: 1050W

50s LINE
.....

Anna

PL41TEM · PL41LEM
PL41EM

Anna is the group of espresso machines **for those who are approaching the world of the prosumer machines**. You'll be amazed to see **how easy it is to get exceptional espressos**. With the multi-directional steam wand you'll make fantastic cappuccinos and you'll have hot water for your American coffees, teas or herbal infusions. Ideal for small families or for those that drink espresso with moderation!

Data sheet

pag
52



Anna

is the character played by Audrey Hepburn in "Vacanze Romane", the movie that led her to the Oscar and brought the Vespa to the fore, an icon of the Italian design of the 50s.

50s LINE
.....

Anita

PLO42TEMD · PLO42EMI
PLO42EM

Only **fresh ground coffee** can enhance the aroma, **the crema and the taste of the real Espresso served in the bar**. Anita is the group of espresso machines for those who love easiness and compactness without compromising the results from the coffee beans extraction. The right machine to obtain the best results with the minimum effort!

Data sheet

pag
54



Anita Ekberg

is a Swedish actress who plays, together with Mastroianni, the scene in the Trevi fountain in Federico Fellini's "Dolce Vita". It is said that during the filming Anita did not have any trouble staying in the water for hours, while Mastroianni had to wear a wet suit under his clothes to endure the cold.



Dimensions: 31,5 x 25,5 x 36,8 cm

Weight: 10,2 kg

Pump: 15 bar

Tank capacity: 2,7 l

Total power: 1200W

ground
coffee



Dimensions: 24x26,5x36,2 cm

Weight: 9 kg

Pump: 15 bar

Tank capacity: 2,7 l

Total power: 1250W

50s LINE

.....

Glenda

PL41PLUST · PL41PLUS

The **commercial group** of the Glenda is able to keep the **brewing temperature constant** even when making several espressos consecutively. This grants excellent **coffees even during intensive use** and withdraw of big quantities of steam for creamy cappuccinos. Lever switches, superior materials and attention to detail make this machine a must for the homes of the passionate espresso connoisseurs.

Data sheet

pag
56



Glenda Farrell

.....

was an American actress of film, television, and theater. With a career spanning more than 50 years, she appeared in over 100 films and television series, as well as numerous Broadway plays. She received a star on the Hollywood Walk of Fame on February 8, 1960.

50s LINE
.....

Diana

PL60R1

Diana is the group of professional machines for those who love to brew not only espressos: **thanks to the two independent coffee and steam boilers you can make as many cappuccinos, teas, herbal infusions as you want**, without compromising the quality of your Espresso.

Thought for an **intensive use of the steam** and for brewing an Espresso worthy of the best bar, Dianas are semi-professional machines for high performances.

Data sheet

pag
58



Diana Loris

.....

is the name used by Gina Lollobrigida at the beginning of her career. At the time, the young actress studied at the "Istituto di Belle Arti" and posed for the photo novels to earn her living.



Dimensions: 30,5x28,5x39,5 cm

Weight: 13,7 kg

Pumps: 48W / 15 bar x2

Tank capacity: 2,5 l

Total power: 2050W



HAVE A LOOK AT THE VIDEO

to discover how to get the best
from our espresso machines



VIP

— Line —

The Vip line is the newest Lelit creation. It's born to satisfy those espresso lovers who expect the best performances from their machine and desire a masterpiece to be admired also when it's off. The elegant surfaces of the brushed stainless steel, the exclusive details and the new LCC make this family of machines the first choice for having the best without compromises.



Families:

**GRACE · VICTORIA · KATE ·
ELIZABETH**

ground
coffee

coffee
pods



Dimensions: 22,5x27x38 cm

Weight: 7,4 kg

Pump: 15 bar

Tank capacity: 2,5 l

Total power: 1050W

VIP LINE
.....

GRACE

PL81T

Grace is the family of espresso machines where we concentrated **the best of technology and design**.

Harmonious lines, innate elegance and **accurate choice of materials and finishing** make this Lelit line a piece of furniture and a superb espresso machine.

Our LCC (electronic control system) that rules the parameters for brewing a coffee is a treat: this line is a must for those who expect an exceptional Espresso with a world class visual effect.

Data sheet

pag
60



Grace Kelly

is considered one of the most beautiful actresses ever seen. On the set of "To catch a thief", filmed in Monaco, she met Prince Ranieri III, her future husband and partner.

VIP LINE

VICTORIA

PL91T

Victoria is the family of espresso machines ideal for those who want the best aesthetics and technology in a small space. In spite of its **reduced dimensions it has a 58mm commercial group**: the bigger boiler capacity and power enable to brew many consecutive espressos maintaining the right temperature and having always enough steam available for cappuccinos, just like in the bars. As all the models of the VIP line, Victoria is equipped with the exclusive LCC, Lelit electronic control system. Smart appearance and ease of use are undeniable aspects for this line of regal look.

Data sheet

pag
61



Queen Victoria

under her sixty-three years long reign England had one of its periods of greatest expansion. She was not only the Queen of the United Kingdom but also the Empress of India.



Dimensions: 22,5x27x38 cm
Weight: 9,2 kg
Pump: 15 bar
Tank capacity: 2,5 l
Total power: 1250W



Dimensions: 33x27x43 cm

Weight: 9,2 kg

Pump: 15 bar

Tank capacity: 2,5 l

Total power: 1400W

VIP LINE
.....

KATE

PL82T

Kate represents the perfect **union between aesthetics and functionality**. A unique line that combines an espresso machine of the highest quality with a professional grinder in just one compact appliance body. Kate is run by the exclusive electronic LCC, assembled on all the VIP line machines. You'll be astonished by its great performances and refined aesthetics.

Data sheet

pag
62



Katharine Hepburn

Katharine Hepburn received 12 Oscar nominations in her career as best actress and won 4 Academy Awards. She's considered the best American actress ever.

VIP LINE
.....

ELIZABETH

PL92T

Thanks to the **double boiler for water and steam**, this line is the top for those who desire an espresso of the highest level and endless steam for creamy cappuccinos without compromise.

With LCC it will be easy to get the best out of this extraordinary machine.

Data sheet

pag
63



Elizabeth I

She was the daughter of Henry VIII and Anne Boleyn and was often called the Virgin Queen, Gloriana or Good Queen Bess. She was the fifth and last monarch of the Tudor dynasty. Cate Blanchett played her role in an historical film in 1998.



Dimensions: 31x27x38 cm

Weight: 12 kg

Pump: 15 bar

Tank capacity: 2,5 l

Total power: 1250W



HAVE A LOOK AT THE VIDEO

to discover how to get the best
from our espresso machines



Pro

— Line —

This group made the history of the Espresso, enabling to brew the best possible espresso at home as well as in the bars.

In this machine, the most compact of its category, you get a technology refined in time, regulation possibilities and prestigious, heavy-duty materials. Elegance and quality for the barista in you!

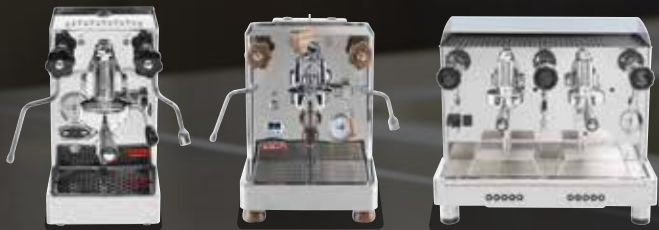

Families:

MARA · BIANCA · GIULIETTA



Dimensions: 22x40x35,5 cm
Weight: 18,8 Kg
Pump: 15 bar
Tank capacity: 2,5 l
Total power: 1500W

PRO LINE

Mara

PL62T · PL62 · PL62S
PL62-W

We implemented **the best technology existing in the coffee world in a machine with a unique and compact design.** A marvelous object to practice the golden rules that allow every real barista to brew the most sensual espresso he can dream of.

Data sheet

pag
64



Mara

is the beautiful Roman prostitute that leads a young seminarian to madness in the third episode of the movie "Ieri, oggi e domani". Mara is played by Sophia Loren, who became famous for her striptease in front of Marcello Mastroianni.

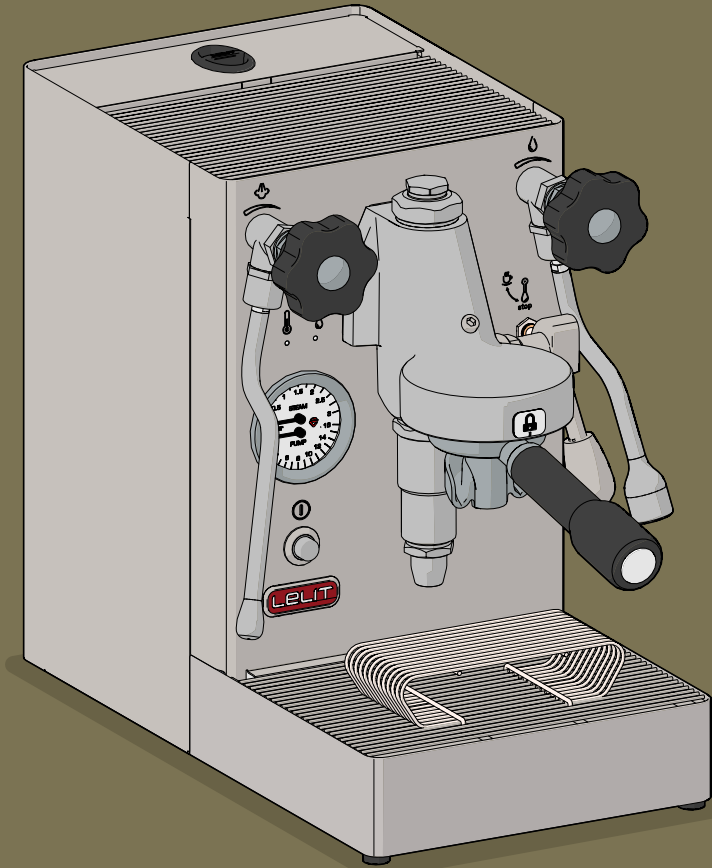

Dimensions: 22x41x35 cm
Weight: 18,8 Kg
Pump: 15 bar
Tank capacity: 2,5 l
Total power: 1500W

PRO LINE

Mara

PL62X

PL62X is the **new LELIT elegant E61 HX machine** with the features of a double boiler!

No need for flushing or for temperature management before making a shot: **Mara X has all the right settings for an optimal extraction**, even with the lighter roasts and the finer grinds.

A stand out piece of beauty **for a satisfying user experience!**

Data sheet

pag
67

PL62X

**will be officially presented
at HOST2019**

Milan
Hall 18 · Stand E78

PRO LINE

Bianca

PL162T

Bianca is the espresso machine that represents the highest technology and design of Lelit product range. **The E61 group is wonderfully embedded in an harmonious and mighty appliance body that hides technological details implemented to grant the best possible performances** to real connoisseurs of the Italian Espresso.

A unique and precious machine that will satisfy you all for its technical features and aesthetical qualities.

Data sheet

pag
59



Bianca

*Bianca is the rebel daughter of Clara and Esteban in the masterpiece of Isabel Allende "The House of the Spirits".
Winona Ryder played her role in the film of 1993, directed by Bille August.*

LELIT
patent
pending



Dimensions: 29x40x40 cm
(+8,5 cm if using the tank)
Weight: 26,5 kg
Rotative pump motor: 150W
Tank capacity: 2,5 l
Total power: 1550W



Dimensions: 58x45x49 cm

Weight: 44 kg

Pump: 150W

Tank capacity: 10 l

Total power: 2950W

PRO LINE

Giulietta

PL2SVH2 · PL2S

For those small bars and pubs that don't want to compromise the espresso quality for their clients. **A machine of exceptional performance** that does not envy anything to its bigger sisters, present in the bars. Thanks to a **concentrate of the best components and available materials**, Giulietta is the ideal partner for those who want to amaze their clients with espressos and cappuccinos of the highest quality.

Data sheet

pag
68



Giulietta Masina

Giulietta Masina plays Gelsomina in the film "La Strada", partner of the unfriendly Zampanò. This play made Federico Fellini internationally famous as a director and won the Oscar in 1956 as best foreign film. It is still nowadays one of the best plays in the film history.



HAVE A LOOK AT THE VIDEO
to discover how to get the best
from our espresso machines



GRINDERS

— Line —

Real connoisseurs know this: the best Espresso can be brewed only with freshly ground coffee that enhances the aroma and all the organoleptic qualities, nuances of each bean.

Lelit grinders distinguish themselves thanks to the refinement of construction and the precision in the grinding regulation. Built entirely in stainless steel they are the ideal partners of every Lelit espresso machine.



Families:

FRED · WILLIAM



Dimensions: 13x22x34 cm

Weight: 3 kg

Bean hopper capacity: 250 g

Total power: 160W

GRINDERS LINE

Fred

PLO44MMT · PLO43MMI
PLO44MM

Fred is the line of **high performing grinders** for blends always freshly ground, a must for the lovers of real Espresso. **It grants** a constant grind of excellent quality in compact dimensions for every space demand.

Data sheet

pag
70



Fred Buscaglione

was, at the end of the 50s, one of the most sought-after entertainers, not only as a singer. He was everywhere: television and movies, first with short singing performances, then as a real actor, almost always playing the tough guy.

GRINDERS LINE

William

PL71

This modern line of **semi-professional grinders** combines **excellent performance with a design that has a strong personality**. Drawn by the pencil of a designer, it stands out for the soft but determined lines, for the innovative form and the royal elegance. Our research and development department target was to give a **rewarding user experience**, combining quality, performance and ease of use and paying attention to every detail and component.

Data sheet

pag
72



William the Conqueror

William I, known as William the Conqueror, was the first Norman King of England, reigning from 1066, after he won the Hastings battle, until September the 9th, 1087.



Dimensions: 14x 22,5 x 36,5 cm

Weight: 6 kg

Bean hopper capacity: 350 g

Total power: 270W



Dimensions: 14 x 22,5 x 38,5 cm cm

Weight: 6,6 kg

Bean hopper capacity: 350 g

Total power: 470W

GRINDERS LINE

William

PL72 · PL72-P

PL72 is Lelit **top grinder**. It enhances **64mm flat mills** to reduce the grinding time, the **graphic interface** of the LCC to program the different grinding parameters and **enable the interaction with the final user and a dose counter** to know how many doses have been ground. Its refined aesthetics makes this grinder the obligatory choice for all real espresso lovers.

Data sheet

pag
73



William Blake

Poet, painter and printmaker of undiscussed talent. He was the inventor of an innovative technique enabling to realize works where his spiritual views could be transferred into the real world.

Anna



Stainless steel appliance body / Tank water level visible from the side / 3 way solenoid valve to dry up the coffee puck / 250 ml brass boiler/ 57 mm filterholder

Water tank: 2,7 l
Coffee/water/steam pump: 15 bar
Dimensions LxDxH: 23x26,5x34 cm
Boiler heating element: 1000W
Voltage: 230V 50Hz
Available upon request also in 120V 60 Hz
Weight: 7,2 kg

Delivered with:

1, 2 cups filters and pod filter.



Anna PL41TEM

- 1 Cup warmer.
- 2 Stainless steel water tray grate.
- 3 Lever switches.
- 4 Multidirectional steam/water wand.
- 5 Manometer for coffee pressure.
- 6 PID boiler temperature controller



Anna
PL41LEM

- 1 Cup warmer.
- 2 Stainless steel water tray cover.
- 3 Lever switches.
- 4 Multidirectional steam/water wand.
- 5 Back lit manometer for coffee pressure.



Anna
PL41EM

- 1 Cup warmer.
- 2 Stainless steel water tray grate.
- 3 Oval chromed switches.
- 4 Steam/water wand.
- 5 Manometer for coffee pressure.

Anita



Stainless steel appliance body / Tank water level visible from the side and from the front / 3 way solenoid valve to dry up the coffee puck / Built-in grinder with Ø 38mm conical burrs and micrometric stepless grinding adjustment / Built-in tamper / 250 ml brass boiler / 57 mm filterholder.

Water tank: 2,7 l
Coffee/water/steam pump: 15 bar
Dimensions LxDxH: 31,5x25,5x36,8 cm
Boiler heating element: 1000W
Voltage: 230V 50Hz
Available upon request also in 120V 60 Hz
Weight: 10,2 kg

Delivered with:

1, 2 cups filters and pod filter.



Anita PLO42TEMD

- 1 Cup warmer.
- 2 Stainless steel water tray grate.
- 3 Lever switches.
- 4 Manometer for coffee pressure.
- 5 Multidirectional steam/water wand.
- 6 PID boiler controller for coffee and steam temperature.



Anita
PLO42EMI

- 1 Cup warmer.
- 2 Stainless steel water tray grate.
- 3 Round stainless steel switches.
- 4 Back lit manometer for coffee pressure.
- 5 Multidirectional steam/water wand.



Anita
PLO42EM

- 1 Cup warmer.
- 2 Stainless steel water tray grate.
- 3 Oval chromed switches.
- 4 Steam/water wand.
- 5 Manometer for coffee pressure.

Glenda



Stainless steel appliance body / Tank water level visible from the side / 3 way solenoid valve to dry up the coffee puck / 300 ml brass boiler / 58 mm commercial filterholder.

Water tank: 2,7 l
Coffee/water/steam pump: 15 bar
Dimensions LxDxH: 24x26,5x36,2 cm
Boiler heating element: 1200W
Voltage: 230V 50Hz
Available upon request also in 120V 60 Hz
Weight: 9 kg

Delivered with:
1 and 2 cups filters.



Glenda PL41PLUST

- 1 Cup warmer.
- 2 Stainless steel water tray cover.
- 3 Lever switches.
- 4 Multidirectional steam/water wand.
- 5 PID boiler temperature controller.



Glenda
PL41PLUS



Tip #01

.....
In order to obtain an espresso with a balanced flavor you need to mix two blends of coffee, Arabica and Robusta. Arabica gives a delicate aroma and the right acidity, whereas Robusta is responsible for the full flavor, the coffee body and crema in the cup. Their proportions in the blend depend on your taste.

- 1 Cup warmer.
- 2 Stainless steel water tray cover.
- 3 Lever switches.
- 4 Multidirectional steam/water wand.
- 5 Boiler thermometer.

Diana



Stainless steel appliance body / Tank water level visible from the side / 3 way solenoid valve to dry up the coffee puck / Possibility to cut off the steam boiler only / Electronic card for steam boiler recharge / 250 ml brass boiler / 600 ml stainless steel steam boiler / Acoustic alarm for lack of water in the tank.

Water tank: 2,5 l
Coffee/water pump: 15 bar
Steam pump: 15 bar
Dimensions LxDxH: 30,5x28,5x39,5 cm
Steam boiler heating element: 1000W
Coffee boiler heating element: 1000W
Voltage: 230V 50Hz
Available upon request also in 120V 60 Hz
Weight: 13,7 kg

Delivered with:

1 and 2 cups filters, pod filter and 35 l resin filter.



Diana PL60R1

- 1 Wide cup warmer.
- 2 Lever switches.
- 3 Multidirectional steam wand.
- 4 Fixed water wand.
- 5 Mug friendly – espresso cup rack.
- 6 57 mm filterholder.
- 7 Manometer for coffee pressure.

Bianca



800 ml stainless steel coffee boiler / 1,5 l stainless steel steam boiler / Professional water-steam taps with spring closure / I/O back-lit stainless steel switch / Programmable pre-infusion parameters through LCC / LCD high resolution graphic display / 58mm filterholder with wood handle and exclusive Coffee Slide / Possibility to connect the machine to the water supply with direct discharge / Possibility to cut off the steam boiler only / Programmable Stand-by function / Partial and total doses counters / Possibility to place the water tank on the three sides of the machine / Mug friendly – espresso cup rack / Mirror polished/ brushed stainless steel appliance body.

Water tank: 2,5 l

Rotative pump motor: 150W

Dimensions WxDxH: 29 x 40 x 40 cm (+8,5 cm if using the tank)

Coffee boiler heating element:

1400W (220-240V 50-60Hz)

Steam boiler heating element:

1400W (220-240V 50-60Hz)

Available also in 120V 60 Hz but with coffee boiler heating element 1000W

Weight: 26,5 kg

Delivered with:

complete Lelit filterholder with 1 cup and 2 cups filters, bottomless Ø58 mm filterholder, blind filter, 70 l resin filter, Lelit stainless steel tamper with aluminium handle, group brush, Lelit microfiber cloth, optional steam wand nozzle.



Bianca PL162T

- 1 Cup warmer.
- 2 Polished water tray in stainless steel.
- 3 Double manometer for pump / steam pressure.
- 4 Manometer for coffee pressure.
- 5 Multidirectional, anti-burn steam/ water wands.
- 6 Knobs, lever and feet in wood.
- 7 PID boiler controller for coffee and steam.
- 8 E61 type group with paddle system to adjust the pressure.

GRACE



Brushed stainless steel appliance body / 3 way solenoid valve to dry up the coffee puck / 250 ml brass boiler / 57 mm filterholder with new Lelit ergonomic handle / Graphic indication for lack of water in the tank / Programmable pre-infusion / Stand-by according to CEI EN 50564 norm / LCD high resolution graphic display.

Water tank: 2,5 l
Coffee/water/steam pump: 15 bar
Dimensions LxDxH: 22,5x27x38 cm
Boiler heating element: 1000W
Voltage: 230-240V 50Hz
Available upon request also in 120V 60 Hz
Weight: 7,4 kg

Delivered with:

1&2 cup filters, pod filter, blind filter and 35 l water resin filter.



Grace
PL81T

- 1 Wide cup warmer.
- 2 Back lit, round switches in stainless steel.
- 3 Multidirectional steam/water wand.
- 4 Mug friendly.
- 5 Wide water tray in stainless steel complete with self-cleaning grate.
- 6 Back lit manometer for coffee pressure.
- 7 LCC - New Lelit electronic control system.
- 8 57mm filterholder with ergonomic handle and exclusive Coffee Slide.

VICTORIA

.....



Brushed stainless steel appliance body / 3 way solenoid valve to dry up the coffee puck / 300 ml brass boiler / 58 mm commercial filterholder with new Lelit ergonomic handle / Graphic indication for lack of water in the tank / Programmable pre-infusion / Stand-by according to CEI EN 50564 norm / LCD high resolution graphic display.

Water tank: 2,5 l
Coffee/water/steam pump: 15 bar
Dimensions LxDxH: 22,5x27x38 cm
Boiler heating element: 1200W
Voltage: 230-240V 50Hz
Available upon request also in 120V 60 Hz
Weight: 9,2 kg

Delivered with:

1&2 cup filters, blind filter and 35 l water resin filter.



Victoria
PL91T

- 1 Wide cup warmer.
- 2 Back lit, round switches in stainless steel.
- 3 Multidirectional steam/water wand.
- 4 Mug friendly.
- 5 Wide water tray in stainless steel complete with self-cleaning grate.
- 6 Back lit manometer for coffee pressure.
- 7 LCC - New Lelit electronic control system.
- 8 58mm filterholder with ergonomic handle and exclusive Coffee Slide.

KATE



Brushed stainless steel appliance body / 3 way solenoid valve to dry up the coffee puck / 300 ml brass boiler / 58mm filterholder with new Lelit ergonomic handle / Graphic indication for lack of water in the tank / Programmable pre-infusion / Built-in grinder with Ø 38mm conical burrs and micrometric stepless grinding adjustment / Stand-by according to CEI EN 50564 norm / LCD high resolution graphic display.

Water tank: 2.5 l
Coffee/water/steam pump: 15 bar
Dimensions: LxDxH: 33x27x43 cm
Boiler heating element: 1200W
Voltage: 230-240V 50Hz
Available upon request also in 120V 60 Hz
Weight: 12 Kg

Delivered with:

1, 2 cups filters, blind filter, 35 l resin filter, steam tip with 2 holes Ø1.



Kate
PL82T

- 1 Wide cup warmer.
- 2 Back lit, round switches in stainless steel.
- 3 Multidirectional steam/water wand.
- 4 Mug friendly.
- 5 Wide water tray in stainless steel complete with self-cleaning grate.
- 6 Back lit manometer for coffee pressure.
- 7 LCC – New Lelit control system.
- 8 58mm filterholder with new Lelit ergonomic Coffee Slide.
- 9 Grinding times for 1 or 2 dosed programmable through LCC.

ELIZABETH



Brushed stainless steel appliance body / 3 way solenoid valve to dry up the coffee puck / 300 ml brass boiler / 600 ml stainless steel steam boiler / 58mm filterholder with new Lelit ergonomic handle / Graphic indication for lack of water in the tank / Possibility to cut off the steam boiler only / Programmable pre-infusion & brew time parameters through LCC / Stand-by according to CEI EN 50564 norm / LCD high resolution graphic display.

Water tank: 2,5 l
Coffee/water/steam pump: 15 bar
Dimensions LxPxH: 31x27x38 cm
Coffee boiler heating element: 1200W
Steam boiler heating element: 1000W
Voltage: 230-240V 50Hz
Available upon request also in 120V 60 Hz
Weight: 12 kg

Delivered with:

1, 2 cups filters, blind filter, 35 l resin filter.



Elizabeth PL92T

- 1 Wide cup warmer.
- 2 Multi-directional, anti-burn steam wand.
- 3 Fixed water wand.
- 4 Mug friendly – espresso cup rack.
- 5 Wide water tray in stainless steel complete with self-cleaning grate.
- 6 Back lit manometer for coffee pressure.
- 7 LCC – New Lelit electronic control system.
- 8 58 mm filterholder with ergonomic handle and exclusive Coffee Slide.
- 9 Back lit, stainless steel switches.

Mara



1.5 l copper boiler with heat exchanger / E61 type group with mechanical pre-infusion / Group heating through thermo-syphonic circulation / Professional water-steam taps with spring closure / 3 way solenoid valve for coffee manometer reset / I/O round, stainless steel switch / Led for machine on / Led for machine in heating process / Acoustic alarm for lack of water in the tank / 58mm commercial filter-holder.

Water tank: 2,5 l
 Coffee/water pump: 15 bar
 Dimensions LxDxH: 22x40x35,5 cm
 Boiler heating element: 1400W
 Voltage: 230V 50Hz
 Available upon request also in 120V 60 Hz
 Weight: 18,8 kg

PL62T/PL62 - Delivered with:

1 cup and 2 cups complete Lelit filterholders, blind filter, 35 l resin filter, Lelit tamper in stainless steel with red wood handle.

PL62S - Delivered with:

1, 2 cups filters, blind filter, 35 l resin filter, plastic tamper.

PL62-W - Delivered with:

1,2 cups filters, blind filter, 35 l resin filter, aluminium tamper.

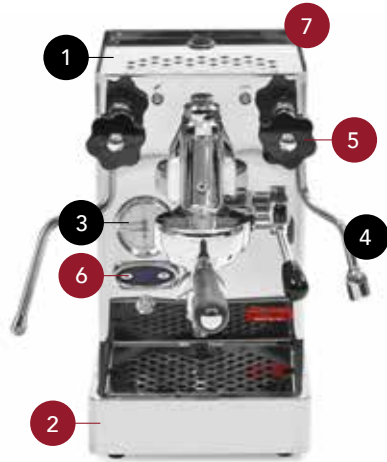

Mara PL62T

- 1 Cup warmer.
- 2 Polished water tray in stainless steel.
- 3 Double manometer for coffee/ steam pressure.
- 4 Multidirectional, anti-burn steam/ water wands.
- 5 Polished old style knobs in phenolic resin with chromed, anti-burn cover.
- 6 PID boiler controller for coffee.
- 7 Mirror polished stainless steel appliance body.

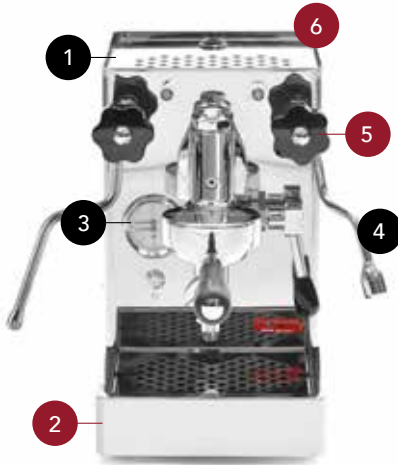

Mara
PL62

- 1 Cup warmer.
- 2 Polished water tray in stainless steel.
- 3 Double manometer for coffee/steam pressure.
- 4 Multidirectional, anti-burn steam/water wands.
- 5 Polished old style knobs in phenolic resin with chromed, anti-burn cover.
- 6 Mirror polished stainless steel appliance body.



Mara
PL62S

- 1 Cup warmer.
- 2 Brushed water tray in stainless steel.
- 3 Double manometer for coffee/steam pressure.
- 4 Multidirectional, anti-burn steam/water wands.
- 5 Satin plastic knobs with anti-burn cover.
- 6 Frontal panel mirror polished, brushed back and lateral panels.

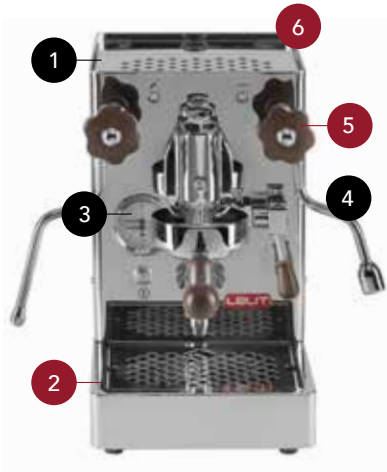

Mara
PL62-W



Tip #02

In order to brew a "state of the art" Espresso, bear in mind the "5M", i.e. the five parameters that make a simple coffee become an Espresso with capital letters: miscela (blend), macinatura (grinding), macchina (espresso machine), manualità (skill) and manutenzione (maintenance).

- 1 Cup warmer.
- 2 Polished water tray in stainless steel.
- 3 Double manometer for coffee/ steam pressure.
- 4 Multidirectional, anti-burn steam/ water wands.
- 5 Nut wood knobs, lever, and portafilter handle.
- 6 Mirror polished stainless steel appliance body.

Mara

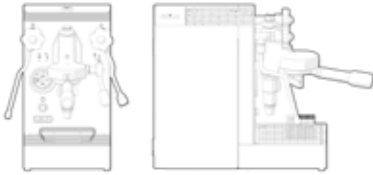

1.8 l stainless steel HX boiler / E61 type group with mechanical pre-infusion / Group heating through thermo-syphonic circulation regulated through a HX double probe system (patent pending) / Professional water-steam taps with spring closure / 3 way solenoid valve for coffee manometer reset / I/O round, stainless steel back-lit switch / Led for lack of water in the tank or tank absence / 58mm commercial filterholder.

PLUS: temperature set by "PID system" and double selector (coffee/steam + set point), "Silent System pump" (patent pending), open water tank with automatic coupling, energy saving mode, double carton box.

Water tank: 2,5 l
Coffee/water pump: 15 bar
Dimensions LxDxH: 22x41x35 cm
Boiler heating element: 1400W
Voltage: 230V 50Hz
Available upon request also in 120V 60 Hz
Weight: 18,8 kg

Delivered with:

Complete Lelit filterholder with inclined handle including 4 filters (LELIT58 9-11 g filter, LELIT58 14-18 g filter, LELIT58 18-21 g filter, LELIT58 blind filter), water resin filter, LELIT58 tamper in stainless steel with red wood handle.

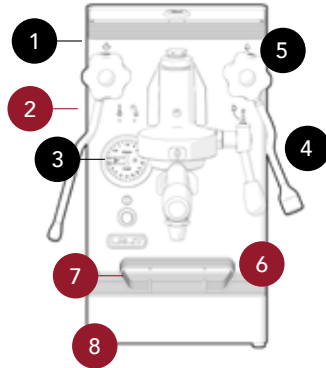

Mara PL62X

- 1 Cup warmer.
- 2 Brushed stainless steel appliance body.
- 3 Double manometer for coffee/steam pressure.
- 4 Multi directional, anti-burn steam/water wands.
- 5 Polished old style knobs in phenolic resin with chromed, anti-burn cover.
- 6 Mug friendly.
- 7 Espresso cup rack.
- 8 Height adjustable feet.

Giulietta



10 l copper boiler / 2 heat exchangers, 0.4 l each, with front injectors / Connection to water supply with direct discharge / Group heating through thermo-syphonic circulation / Rotative pump / Automatic boiler level control and heating phase / Appliance body in stainless steel: front and back panels mirror polished, brushed lateral panels / Adjustable feet / Stainless steel water tray complete with self-cleaning grate / It delivers: 4 espresso/minute per group, 2 coffee/minute per group, 60 cl/minute of hot water / Cup warmer with cup holder.

Boiler heating element: 2800W
Pump motor: 150W
Dimensions: 58x45x49 cm
Voltage: 220V-240V 50Hz-60Hz
Weight: 44 kg

Delivered with:

1 cup and 2 cups complete filterholders, blind filter and plastic tamper.

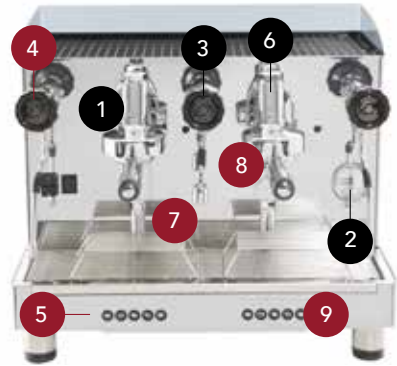

Giulietta PL2SVH2

- 1 E61 type automatic groups.
- 2 Double manometer for coffee/steam pressure.
- 3 1 multidirectional water wand.
- 4 2 multidirectional steam wands.
- 5 Programmable automatic coffee dosing.
- 6 2 groups and chromed taps NSF approved.
- 7 Mug friendly – espresso cup rack.
- 8 Pre-infusion programmable on all doses.
- 9 Automatic washing cycle for each group.



Giuletta PL2S

- ❶ E61 type groups with mechanical pre-infusion.
- ❷ Double manometer for coffee/steam pressure.
- ❸ 1 multidirectional water wand.
- ❹ 1 Multidirectional steam/water wand.
- ❺ Groups and chromed taps NSF approved.



Tip #03

.....
A good tamper must be heavy to apply the correct pressure on the coffee powder. The right weight to be applied should be around 20 kg. Pay attention not to over-press: if the coffee powder is overpressed, the espresso will be too intense.

Fred



Grinder on demand / Stainless steel
appliance body / Ø38 mm conical mills.



Fred PLO44MMT

- ❶ Micro-metric stepless grinding adjustment.
- ❷ Coffee chute, filterholder support and grinding switch in stainless steel.
- ❸ Automatic dosing, programmable for 1 or 2 coffee shots.

Technical data

.....
Bean hopper capacity: 250 g
Dimensions LxDxH: 13x22x34 cm
Power: 150W
Voltage: 220-230V 50-60Hz
Available upon request also in 120V 60 Hz
Weight: 3 kg



Fred
PLO43MMI

- 1 Micro-metric stepless grinding adjustment.
- 2 Coffee chute, filterholder support and grinding switch in stainless steel.

Technical data

.....

Bean hopper capacity: 250 g
Dimensions LxDxH: 12x18x30,5 cm
Power: 150W
Voltage: 220-230V 50-60Hz
Available upon request also in 120V 60 Hz
Weight: 2,8 kg

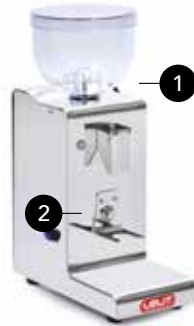

Fred
PLO44MM

- 1 Micro-metric stepless grinding adjustment.
- 2 Coffee chute, filterholder support and grinding switch in stainless steel.

Technical data

.....

Bean hopper capacity: 250 g
Dimensions LxDxH: 13x22x34 cm
Power: 150W
Voltage: 220-230V 50-60Hz
Available upon request also in 120V 60 Hz
Weight: 3 kg

William



Automatic grinder on demand / Satin stainless steel appliance body

PL72:

Productivity espresso: 2,8 g-s

Productivity cafe creme: 3 g-s.

PL71:

Productivity espresso: 1 g-s

Productivity cafe creme: 1,35 g-s.



William PL72

- 1 Micro-regulation of the grinding.
- 2 Coffee chute adjustable in height.
- 3 Wide magnetic tray for coffee rests.
- 4 Filterholder support in stainless steel.
- 5 LCC to regulate the grinding time and counter the ground doses.
- 6 Ø 64mm flat burrs.

NB PL72-P polished version of PL72 with the same technical feature but white LCC control panel.

Technical data

Bean hopper capacity: 350 g
Dimensions LxDxH: 14x22,5x38,5 cm
Power: 470W
Voltage: 230-240V 50-60Hz
Available upon request also in 120V 60Hz
Weight: 6,6 kg



William PL71

- ❶ Micro-regulation of the grinding.
- ❷ Coffee chute adjustable in height
- ❸ Wide magnetic tray for coffee rests.
- ❹ Filterholder support in stainless steel.
- ❺ Switch for setting the grinding time.
- ❻ Ø50 mm flat mills.

Technical data

.....

Bean hopper capacity: 350 g
Dimensions LxDxH: 14x22,5x38,5 cm
Power: 270W
Voltage: 230-240V 50-60Hz
Available upon request also in 120V 60 Hz
Weight: 6,6 kg



Tip #04

.....

The micrometric grinding is a technology that enables the unlimited regulation of the distance between the mills and makes the desired grinding degree extremely precise.





Barista TOOLS

All you need to have a complete
experience in the world of
Lelit espresso

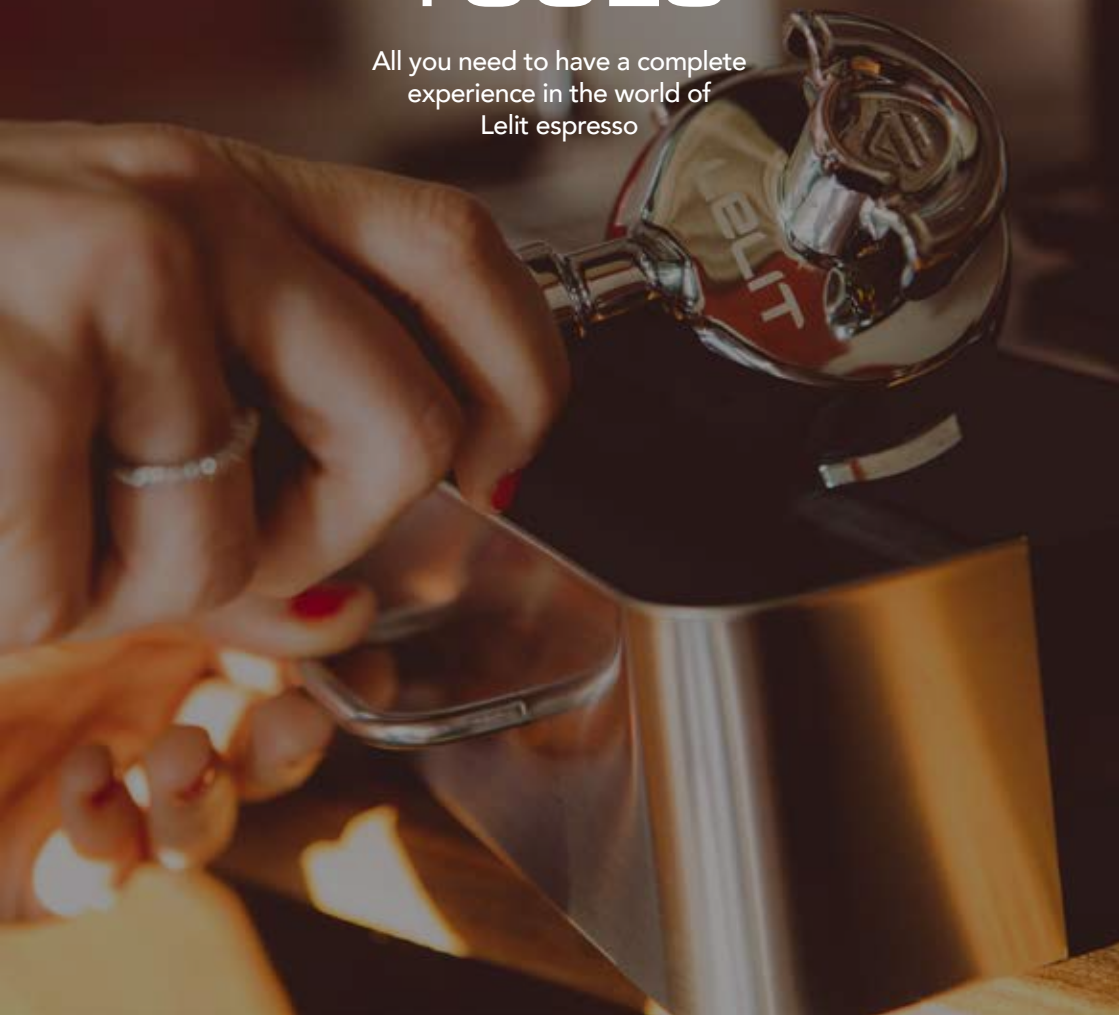



Filters

PLA170S

Set of stainless steel filters for LELIT57 line: 1 dose (7-9 gr) filter, 2 doses (14-18 gr) filter, 2 doses plus (18-21 gr) filter, pod filter, blind filter and pressurized filter.

PLA180S

Set of stainless steel filters for LELIT58 line: 1 dose (9-11 gr) filter, 2 doses (14-18 gr) filter, 2 doses plus (18-21 gr) filter, blind filter and pressurized filter.

Filterholders *Standard*

PLA570S LELIT57

LELIT57 bottomless filterholder, with black handle and 2 doses plus (18-21 gr) filter.

PLA571S LELIT57

LELIT57 1-way filterholder, with black handle and 3 filters: 1 dose (7-9 gr), blind and pods filter.

PLA572S LELIT57

LELIT57 2-ways filterholder, with Coffee Slide spout, black handle and 5 filters: 1 dose (7-9 gr), 2 doses (14-18 gr), 2 doses plus (18-21 gr), blind and pods filter.

PLA580S LELIT58

LELIT58 bottomless filterholder, with black handle and 2 doses plus (18-21 gr) filter.

PLA582S LELIT58

LELIT58 2-ways filterholder, with Coffee Slide spout, black handle and 4 filters: 1 dose (9-11 gr), 2 doses (14-18 gr), 2 doses plus (18-21 gr) and blind filter.



PLA585S LELIT58

LELIT58 1-way filterholder for Giuletta, with black, inclined handle and 3 filters: 1 dose (7-9 gr), 1 dose (9-11 gr) and blind filter.

PLA586S LELIT58

LELIT58 2-ways filterholder for Giuletta, with black, inclined handle and 3 filters: 2 doses (14-18 gr), 2 doses plus (18-21 gr) and blind filter.

PLA583S LELIT58

LELIT58 pressurized filterholder for FAP compatible capsules, with black handle.

PLA584S LELIT58

LELIT58 adjustable filterholder for paper pods, with black handle.

Filterholders *Wood Line*

.....



PLA580W

LELIT58 bottomless filterholder for Wood Line, with walnut, inclined wood handle and 2 doses plus (18-21 gr) filter.

PLA582W

LELIT58 2 ways-filterholder for Wood Line, with Coffee Slide spout, inclined walnut handle and 4 filters: 1 dose (9-11 gr), 2 doses (14-18 gr), 2 doses plus (18-21 gr) and blind filter.

Filterholders *Vip Line*

.....

PLA570V LELIT57

LELIT57 bottomless filterholder for Vip Line with brown handle and 2 doses plus (18-21 gr) filter.

PLA572V LELIT57

LELIT57 2-ways filterholder for VIP Line, with Coffee Slide spout, brown handle and 5 filters: 1 dose (7-9 gr), 2 doses (14-18 gr), 2 doses plus (18-21 gr), blind and pods filter.

PLA580V LELIT58

LELIT58 bottomless filterholder for Vip Line with brown handle and 2 doses plus (18-21 gr) filter.



PLA582V LELIT58

LELIT58 2-ways filterholder for VIP Line, with Coffee Slide spout, brown handle and 4 filters: 1 dose (9-11 gr), 2 doses (14-18 gr), 2 doses plus (18-21 gr) and blind filter.



Coffee leveller

.....

PLA472A – PLA482A

Pre-tamp stainless steel coffee leveller with adjustable height and black aluminium handle for LELIT57 and LELIT58 filterholders.

Tampers

PLA471A – PLA481A

Lelit stainless steel tamper with aluminium handle and professional details for LELIT57 and LELIT58 filterholders.

PLA471R – PLA481R

Lelit stainless steel tamper with red wood handle and professional details for LELIT57 and LELIT58 filterholders.

PLA471W – PLA481W

Lelit stainless steel tamper with bicolour wood handle and professional details for LELIT57 and LELIT58 filterholders.



Knock box drawer Basket kits

PLA360S

Lelit cylindrical knock box Ø 10.5 cm with microfiber cloth and brush.

PLA360M

Lelit VIP knock box drawer with microfiber cloth, brush and magnetic container for accessories storage.

Milk jug kits

PLA301S – PLA301M – PLA301L

Stainless steel milk jug (small 35cl PLA301S – medium 50cl PLA301M – large 75cl PLA301L) complete of a latte art pen.





Barista tools

PLA3800

Stainless steel thermometer in C° and F° scale, with fixing clip.

PLA4000

Lelit tamping station.

PLA9101

Lelit microfiber cloth with embroidered logo and ring, Lelit paintbrush and brush.

Cleaning products

PLA9201

40 single-dose bags (3.5 gr / each) of detergent powder for brewing group cleaning and a rubber universal blind filter.

PLA9202

20 single-dose bags (15 gr / each) of detergent crystals for grinder's mills cleaning.

PLA9203

10 single-dose bottles (25 ml/each) of detergent for steam wands cleaning.



Upgrade kits

.....

PLA2200

Walnut wood water / steam knobs and lever for MARA family machines.

PLA2400

Manometer for E61 groups with fixing pin, wrench, nuts, washers and o-rings.



PLA580W

LELIT58 bottomless filterholder with walnut wood handle and 2 doses plus (18-21 gr) filter.

PLA582W

LELIT58 2-ways filterholder with Coffee Slide spout, walnut wood handle and 4 filters: 1 dose (9-11 gr), 2 doses (14-18 gr), 2 doses plus (18-21 gr) and blind filter.



Cups

.....

PL300

70cc Lelit porcelain espresso cup with saucer, 6pcs.

PL302

190cc Lelit porcelain cappuccino cup with saucer, 6pcs.

PL303

270cc Lelit porcelain milk cup with saucer, 6pcs.





Water softeners

AM5L

5L water softener.

AM8L

8L water softener.

AM12L

12L water softener.

AM16L

16L water softener.

AM20L

20L water softener.

Resin filters

PLA930S

2 pcs resin filters
for 35 l each.

PLA930M

2 pcs resin filters
for 70 l each.







All Lelit models are the result of Italian creativity and technology. We commit ourselves in producing equipment with great attention to quality and details. This is what Made in Italy stands for and this is what made these products renowned all over the world.

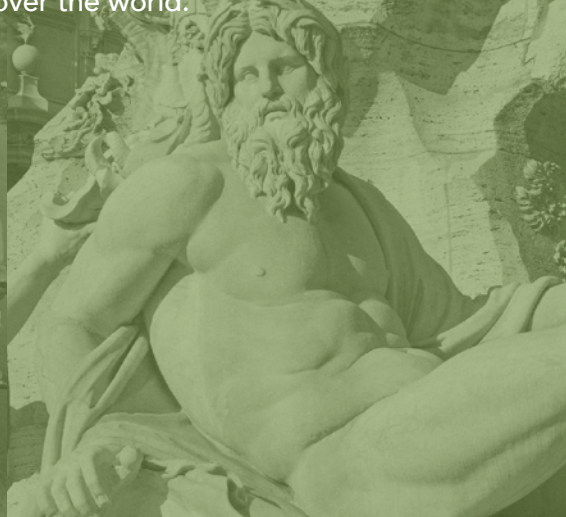

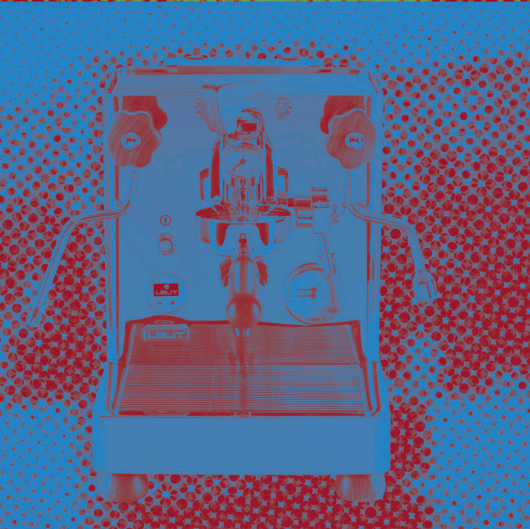

Gemme Italian Producers Srl

via del Lavoro 45
25045 Castegnato (BS) Italy
espresso.lelit.com

6000013 - REV04 - 01/08/2019